

ETHOS

295 x 120 x H.215

SAUNA + SHOWER with Turkish bath

VERS. RX

SAUNAVITA®
calore naturale

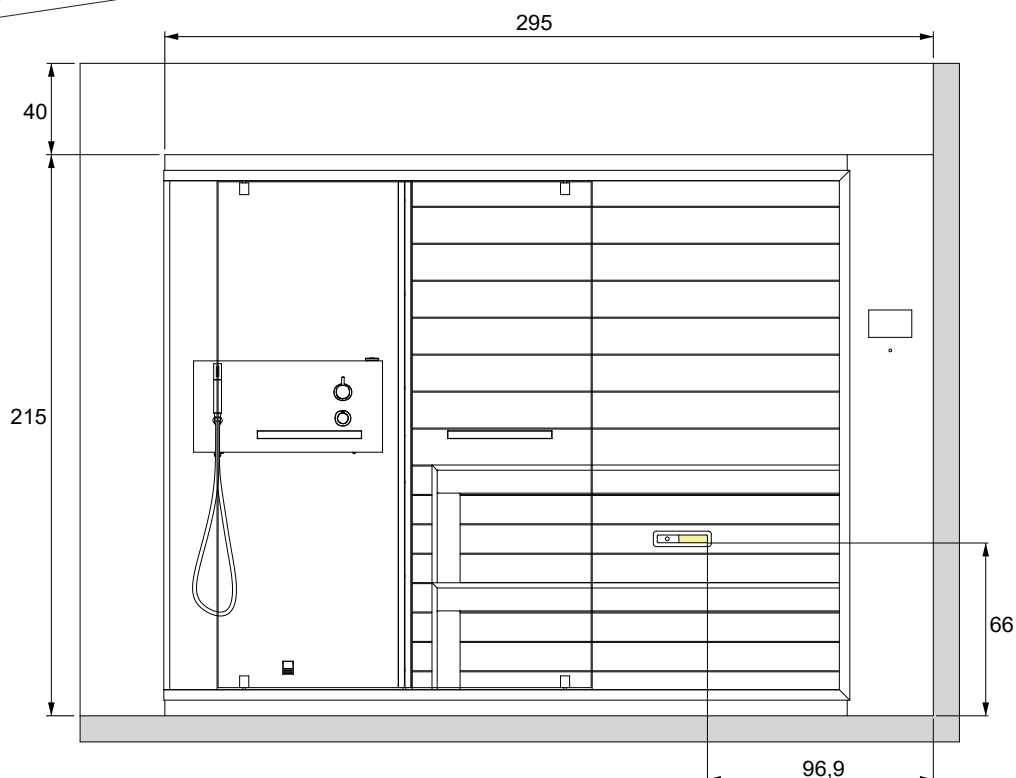
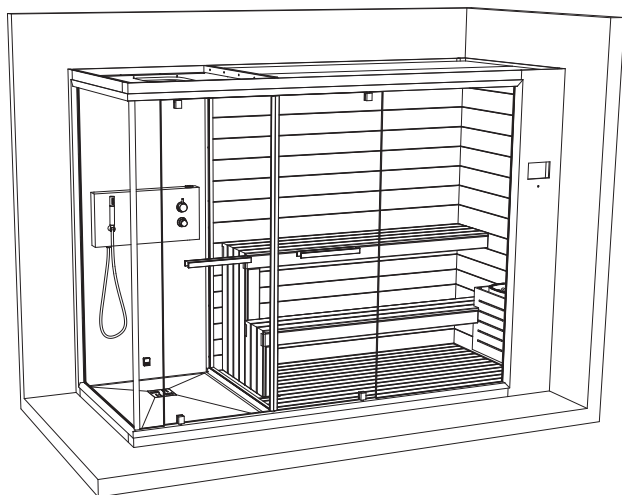

The overall dimension values are expressed in centimetres.
The actual dimensions may vary by ± 1 cm.

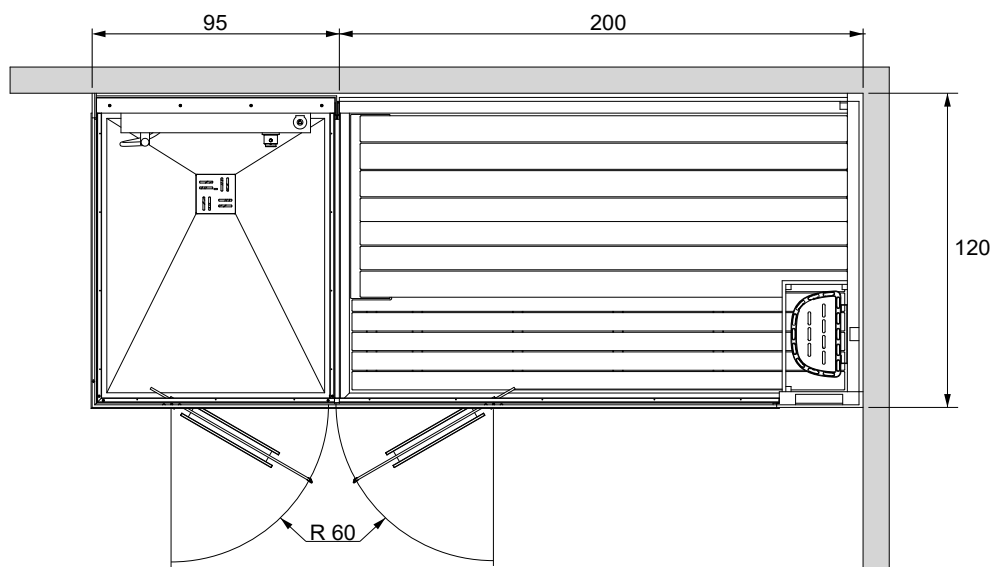

The minimum height of the wall tiles without protrusions is equal to the height of the stall.
On the walls there cannot be any greca or quarter round decorative patterns.

ETHOS 295 x 120 x H.215

SAUNA + SHOWER with Turkish bath

VERS. RX

Electrical and plumbing provisions

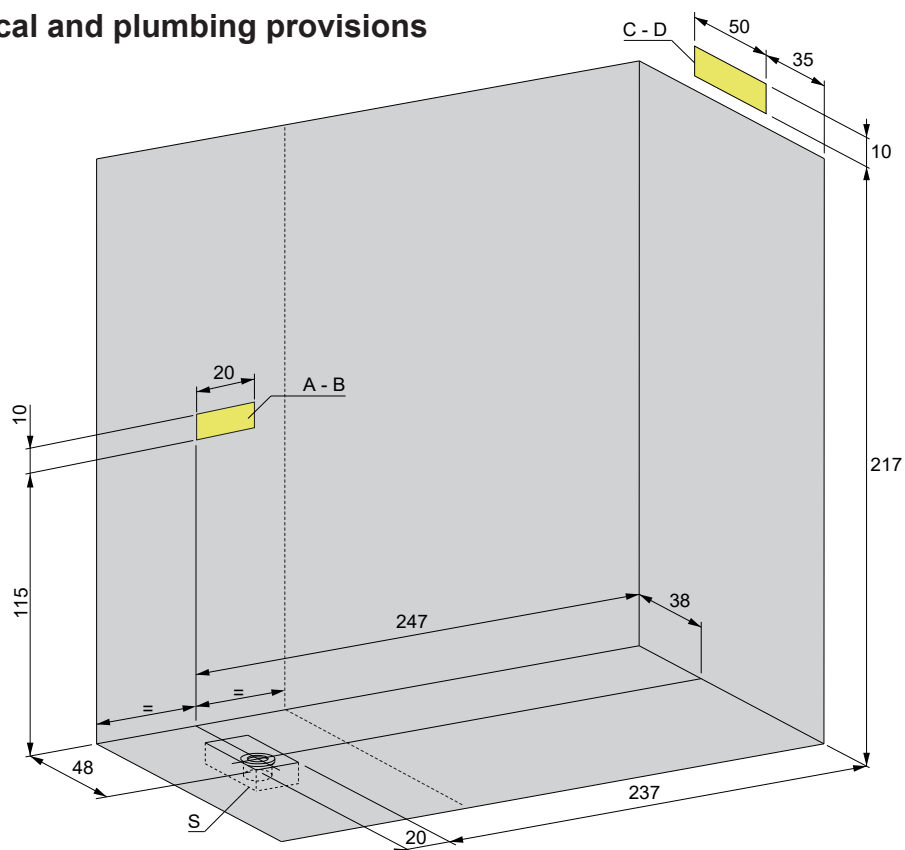

KEY

A - B : Water wall connections

A - 1/2" F cold water wall connection (1,5-3,0 BAR).

B - 1/2" F hot water wall connection (1,5-3,0 BAR).

C - D : Electrical tube outlet



C - Power cable outlet (SINGLE PHASE OR THREE PHASE)

D - Equipotential cable outlet.

S - Shower drain Ø 40mm.

If the water pressure is higher than indicated, install pressure reducers.

Provide shut-off cocks out of the dimensions of the product for hot and cold water closing.

	Operating pressure:
	- MIN 150 kPa (1,5 bar)
	- MAX 300 kPa (3,0 bar)
	Hot water temperature:
	- MAX 60°C (140°F)

Provide waterproof sheathing

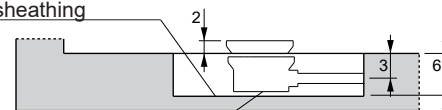

Tube with sleeve Ø 40mm

ELECTRICAL CHARACTERISTICS		RESISTANCES	KW	KW tot.	MAXIMUM TEMPERATURE
230 V ~ 50/60 HZ	SAUNA	2 x 1800 W	3.6	6.1	100 °C
	TURKISH BATH	1 x 2500 W	2.5		50 °C
400 V 50/60 HZ 3N ~	SAUNA	2 x 1800 W	3.6	6.1	100 °C
	TURKISH BATH	1 x 2500 W	2.5		50 °C

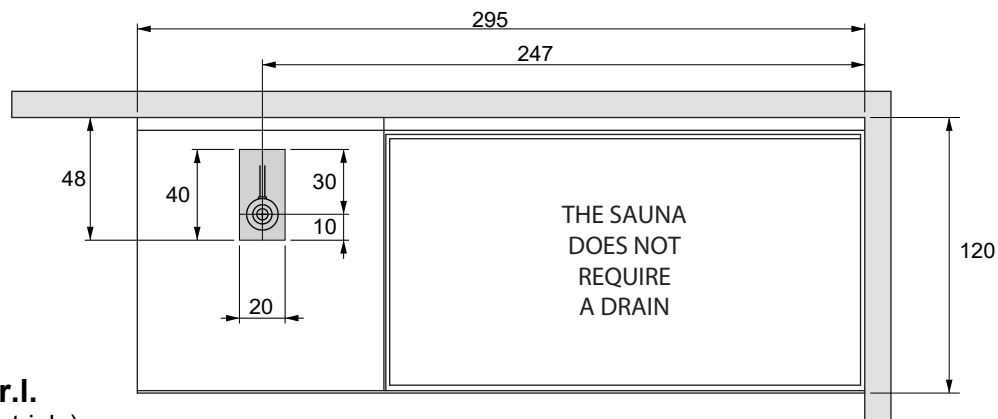

GRUPPO GEROMIN S.r.l.

Via I° Maggio n°5 (zona Industriale)

30029 San Stino di Livenza VE

Tel. +39 0421 312249 / +39 0421 312250

http: www.gruppogeromin.com - email: info@gruppogeromin.com